

# RODEX



## PRODUCT CATALOGUE

 [rodexpower.com](http://rodexpower.com)

   [RODEXTOOLS](#)





## PROFESSIONAL HAND TOOLS



# RODEX



**COMBINATION PLIER**



CODE	FEATURES	PCS
RHT0301100006	6" 160 MM	6/60
RHT0301100007	7" 180 MM	6/60
RHT0301100008	8" 200 MM	6/60

**SIDE CUTTING PLIER**



CODE	FEATURES	PCS
RHT0302100006	6" 160 MM	6/60

**LONG NOSE PLIER**



CODE	FEATURES	PCS
RHT0303100006	6" 160 MM	6/60

**COMBINATION PLIER**



CODE	FEATURES	PCS
RHT0301200006	6" 160 MM	6/60
RHT0301200007	7" 180 MM	6/60
RHT0301200008	8" 200 MM	6/60

**SIDE CUTTING PLIER**



CODE	FEATURES	PCS
RHT0302200006	6" 160 MM	6/60

**LONG NOSE PLIER**



CODE	FEATURES	PCS
RHT0303200006	6" 160 MM	6/60



### COMBINATION PLIER



STEEL  
**CR-V**

55-60  
HRC

DIN  
5749

CARBON  
STEEL



CODE	FEATURES	PCS
RHT0301300006	6" 160 MM	6/60
RHT0301300007	7" 180 MM	6/60
RHT0301300008	8" 200 MM	6/60

### SIDE CUTTING PLIER



STEEL  
**CR-V**

55-60  
HRC

DIN  
5749

CARBON  
STEEL



CODE	FEATURES	PCS
RHT0302300006	6" 160 MM	6/60

### LONG NOSE PLIER



STEEL  
**CR-V**

55-60  
HRC

DIN  
5749

CARBON  
STEEL



CODE	FEATURES	PCS
RHT0303300006	6" 160 MM	6/60

### ISOLATED COMBINATION PLIER



1000V

STEEL  
**CR-V**

55-60  
HRC

DIN  
5749

CARBON  
STEEL



CODE	FEATURES	PCS
RHT0301400006	6" 160 MM	6/60
RHT0301400007	7" 180 MM	6/60
RHT0301400008	8" 200 MM	6/60

### ISOLATED SIDE CUTTING PLIER



1000V

STEEL  
**CR-V**

55-60  
HRC

DIN  
5749

CARBON  
STEEL



CODE	FEATURES	PCS
RHT0302400006	6" 160 MM	6/60

### ISOLATED LONG NOSE PLIER



1000V

STEEL  
**CR-V**

55-60  
HRC

DIN  
5749

CARBON  
STEEL



CODE	FEATURES	PCS
RHT0303400006	6" 160 MM	6/60



**MINI COMBINATION PLIER**



STEEL  
**CR-V**

55-60  
HRC

DIN  
5749



CODE	FEATURES	PCS
RHT0301110005	5" 135 MM	12/120

**MINI SIDE CUTTING PLIER**



STEEL  
**CR-V**

55-60  
HRC

DIN  
5749



CODE	FEATURES	PCS
RHT0302110005	4.5" 120 MM	12/120

**MINI LONG NOSE PLIER**



STEEL  
**CR-V**

55-60  
HRC

DIN  
5749



CODE	FEATURES	PCS
RHT0303110005	5" 130 MM	12/120

**MINI COMBINATION PLIER**



STEEL  
**CR-V**

55-60  
HRC

DIN  
5749



CODE	FEATURES	PCS
RHT0301210005	5" 130 MM	12/240

**MINI SIDE CUTTING PLIER**



STEEL  
**CR-V**

55-60  
HRC

DIN  
5749



CODE	FEATURES	PCS
RHT0302210005	4.5" 120 MM	12/240

**MINI LONG NOSE PLIER**



STEEL  
**CR-V**

55-60  
HRC

DIN  
5749



CODE	FEATURES	PCS
RHT0303210005	5" 130 MM	12/240



### ADJUSTABLE WRENCH



- » Wide operating range
- » High strength – wear resistance
- » The chrome plating protects the tool from corrosion
- » Slip-resistant grip for secure control of the tool

CODE	FEATURES	PCS
RHT0309200006	6" 150 MM	6/120
RHT0309200008	8" 200 MM	6/72
RHT0309200010	10" 250 MM	6/48
RHT0309200012	12" 300 MM	6/36

### ADJUSTABLE WRENCH



- » Wide operating range
- » High strength – wear resistance
- » The chrome plating protects the tool from corrosion
- » Slip-resistant grip for secure control of the tool

CODE	FEATURES	PCS
RHT0309100006	6" 150 MM	6/60
RHT0309100008	8" 200 MM	6/60
RHT0309100010	10" 250 MM	6/36
RHT0309100012	12" 300 MM	6/24

### WATERPUMP PLIER



- » Wear resistance
- » Black phosphate coating
- » Adjustable grooved mechanism
- » Slip-resistant grip for secure control of the tool

CODE	FEATURES	PCS
RHT0311200010	10" 250 MM	6/36

### LOCKING PLIER



- » The tool is equipped with a screw that adjusts the clamping force of the jaws
- » A special spring contributes to the rapid opening of the tool

CODE	FEATURES	PCS
RHT0307200010	10" 250 MM	6/48

### LOCKING PLIER



- » The tool is equipped with a screw that adjusts the clamping force of the jaws
- » A special spring contributes to the rapid opening of the tool

CODE	FEATURES	PCS
RHT0307100010	10" 250 MM	6/36

### C-TYPE WELDING CLAMP



NICKEL PLATED



- » The RODEX hand held point clamp is a heavy duty forged steel fixture with carefully hardened gripping parts. The tool is designed for use in metalworking, assembly, repair and welding.

CODE	FEATURES	PCS
RHT0307220011	11" 275 MM	6/36



**SHEET METAL CLAMP**



NICKEL PLATED

» Locks Down Tightly for a Secure Grip  
With the RODEX Original Locking Sheet Metal Tool forming, bending, and crimping sheet metal is easy for precise work. The Original Locking Mechanism stays adjusted for repetitive use, while the classic guarded trigger keeps the tool securely attached until you're ready to let go.



CODE	FEATURES	PCS
RHT0307210010	10" 250 MM	4/24

**PIPE WRENCH TWO HANDLE**



- » Straight jaws
- » Jaw hardness - 50 hrc
- » Cast body
- » Painted
- » Strong notches
- » Wide grip



CODE	FEATURES	PCS
RHT0310100001	1" 40 MM	1/36
RHT0310100015	1-1/2" 55 MM	1/24
RHT0310100002	2" 67 MM	1/12

**STEEL WIRE ROPE SCISSORS**



» Provides a clean and high quality cut

» Suitable for cutting all kinds of carbon steel wire rope up to 3 mm in diameter



52 HRC

CODE	FEATURES	PCS
RHT0604100008	8" 200mm	6/60

**MINI BOLT CUTTER**



52 HRC

- » Mini bolt cutter can be used to cut wide range of items such as nets, bolts, screws, chain, baling wire, electric wire...
- » Ergonomic handle is non-slip and soft grip.
- » The toughness of the cutting blade is high frequency quenched and heat treated HRC 52.
- » The size of the opening can be adjusted by the nut on the body. Max. opening is 5mm, max cutting capacity is 2.3mm.



CODE	FEATURES	PCS
RHT0604110008	8" 200mm	12/72

**BOLT CLIPPERS**



52 HRC

» The RODEX bolt cutter is used to remove various types of bolts, cut cables, wires and metal rods. Long arm grips are equipped with ergonomic pads for more comfortable operation. Shafts best transfer the force to the cutting edges. Cutting edges - HRC 52, handles - steel 45.



CODE	FEATURES	PCS
RHT0605100018	18" 450MM	1/20
RHT0605100024	24" 600MM	1/10
RHT0605100030	30" 750MM	1/5
RHT0605100036	36" 900MM	1/5
RHT0605100042	42" 1050MM	1/3

**FENCING PLIERS**



60-62 HRC

» Fencing Pliers are highly versatile thanks to having a hammer to drive fence staples, a main jaw with 40mm jaw capacity to grip staples and pull them out of the post, extra jaws to stretch and splice wires and as an added bonus, includes two wire cutters. Plier has slip-resistant cushion grip handle for convenience in use.

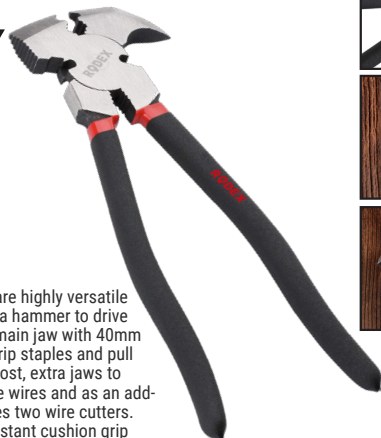

CODE	FEATURES	PCS
RHT0604130105	10,5" 270mm	6/24



### TOWER PINCER



» The thin head design permits good accessibility in confined areas and will not damage the press points on the ear clamps.

» Non-slip grip handles which is convenient for your installation.

CODE	FEATURES	PCS
RHT0305100010	10" 250 MM	6/60
RHT0305100012	12" 300 MM	6/24

### TOWER PINCER



» Made with premium high-carbon, drop-forged, polished steel for durability and an electronic coating to help prevent rusting.

» The high leverage vinyl-dipped handles provide exceptional leverage and have a comfort-grip coating for firm command and control.

CODE	FEATURES	PCS
RHT0305200006	6" 150 MM	6/120
RHT0305200007	7" 175 MM	6/96
RHT0305200008	8" 200 MM	6/72

### AVIATION TIN SNIPS

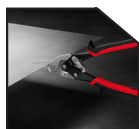

» Designed to cut up to 1.2mm thickness of sheet metal  
 » Blade locking mechanism - safe storage and transportation

CODE	FEATURES	PCS
RHT0603120010	10" 250mm Straight Cut	6/60
RHT0603120012	12" 300mm Long Cut	6/48

### AVIATION TIN SNIPS



» Designed to cut up to 1.2mm thickness of sheet metal  
 » Blade locking mechanism - safe storage and transportation

CODE	FEATURES	PCS
RHT0603130010	10" 250mm Right Cut	6/48

### AVIATION TIN SNIPS



» Designed to cut up to 1.2mm thickness of sheet metal  
 » Blade locking mechanism - safe storage and transportation

CODE	FEATURES	PCS
RHT0603140010	10" 250mm Left Cut	6/48

### MULTI ANGLE SCISSORS



» Shears are able to cut flat cables, chamfer, round molds, trunking and pvc strips, rubber gaskets, molding and weatherstrip, decorative wood etc.. The product is equipped with a built-in miter ruler with marking of various angles between 45°-135°..



CODE	FEATURES	PCS
RHT0606200001	8" 45-135°	10/40



**PRUNING SHEARS**



» The RODEX garden pruner is suitable for cutting shoots and branches of plants. The blades are made of high carbon steel, making them durable and wear-resistant. Equipped with corrosion-resistant and anti-slip coating. A blade locking latch is provided for safe storage and transport of the pruning shears



CODE	FEATURES	PCS
RHT0601110008	8" 200MM	12/60

**PRUNING SHEARS**



**ROTARY ARM**

» The RODEX anvil contact pruner stands out among the entire RODEX scissors series with its ergonomic bypass pruner shape, short cutting head and rotating handle that reduces stress on the hand and wrist. The tool is perfect for pruning branches, shoots and picking fruit.



CODE	FEATURES	PCS
RHT0601120008	8"-200MM	12/60

**PVC PIPE CUTTER**



» The Libraton PVC pipe cutter body is made of durable hardness aluminum alloy steel. The thick 2.5mm blade used is SK5 material with precision sharpened and Teflon coated. Sturdy construction and big size suitable for heavy-duty use.

CODE	FEATURES	PCS
RHT0606100042	42MM (1-5/8")	6/48

**PVC PIPE CUTTER**

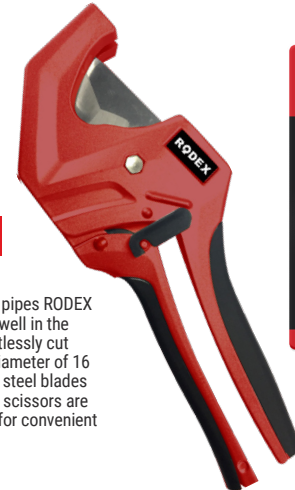

» Scissors for cutting plastic pipes RODEX are a hand-held tool that fits well in the hand and allows you to effortlessly cut polypropylene pipes with a diameter of 16 to 42 mm. Durable body with steel blades resistant to heavy loads. The scissors are equipped with a handle lock for convenient and safe storage.

CODE	FEATURES	PCS
RHT0606110042	42MM (1-5/8")	6/24

**PVC PIPE CUTTER**







» Scissors for cutting plastic pipes RODEX are a hand-held tool that fits well in the hand and allows you to effortlessly cut polypropylene pipes with a diameter of 16 to 42 mm. Durable body with steel blades resistant to heavy loads. The scissors are equipped with a handle lock for convenient and safe storage.

CODE	FEATURES	PCS
RHT0606120042	42MM (1-5/8")	6/48

**HAND RIVETER**



-  2.4mm (3/32")
-  3.2mm (1/8")
-  4.0mm (5/32")
-  4.8mm (3/16")

CODE	FEATURES	PCS
RHT0403100009	9.5"	6/24



## WIRE STRIPPER



- » Wire stripper is used for easily peeling off the insulation layer without damaging the wire.
- » Long lasting usage and sharpness.
- » Spring lock design is suitable for one hand operation and carriage in toolbox.
- » The handle is made of anti-slip PP + TPR material with comfortable feel and ergonomic design.

CODE	FEATURES	PCS
RHT0401100007	7" / Ø 1.6-3 mm	10/120

## AUTOMATIC WIRE STRIPPER



- » Strip wire with our self-adjusting mechanism.
- » 3 in 1 Function as wire stripping, wire cutting, and crimp insulated and non-insulated terminals.
- » Non-slip PP grip.
- » Stripping size range is 0.5 - 6.0 mm²

CODE	FEATURES	PCS
RHT0401110008	7" / Ø 0.5-6.0 mm	6/54

## AUTOMATIC WIRE STRIPPER



- » Clean strip of wires with ease.
- » Compound action stripping via single-action squeezing motion.
- » Precision machined stripping holes easily remove insulation without damaging the wire.
- » During stripping the wire, jaws gently hold the cable.

CODE	FEATURES	PCS
RHT0401120007	8" / Ø 0.5-6.0 mm	12/48

## WIRE STRIPPER



- » Wire stripper is used for easily peeling off the insulation layer without damaging the wire.
- » It has universal mechanism so that it's way easier, faster and more precise than old school gauge strippers.
- » Stripping size range is 0.5mm²-2.5mm² and cutting size range is 3.5mm²
- » Tension adjustable knob for adjusting the pulling force to avoid damaging the wire core.

CODE	FEATURES	PCS
RHT0401130007	175 mm / Ø 0.5-2.5 mm	12/48

## NETWORK CABLE CRIMPER



- » it has a sturdy design and is made of high quality, durable materials that will last a lifetime.
- » precision crimping dies was made of high-carbon steel for any ethernet or telephone cable.

CODE	FEATURES	PCS
RHT0402100068	Connector Type RJ- RJ45 (6P-8P)	12/48

## NETWORK CABLE CRIMPER



- » it has a sturdy design and is made of high quality, durable materials that will last a lifetime.
- » precision crimping dies was made of high-carbon steel for any ethernet or telephone cable.

CODE	FEATURES	PCS
RHT0402110068	RJ45 (8P-8C)	12/48



**SOCKET WRENCH SET**

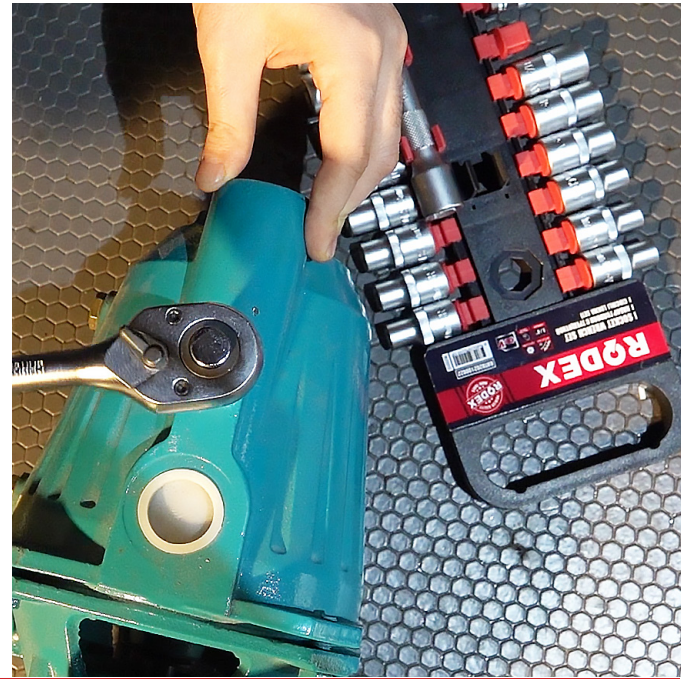

CODE	FEATURES	PCS
RHT0202100022	1/2" 22 Pcs.	1/10

**COMBINATION SPANNER SET**



CODE	FEATURES	PCS
RHT0102100008	(8 Шт) 8-10-12-13-14-15-17-19mm	15
RHT0102100014	(14 Шт) 8-9-10-11-12-13-14-15-16-17-18-19-22-24mm	10

**RATCHET SPANNER**

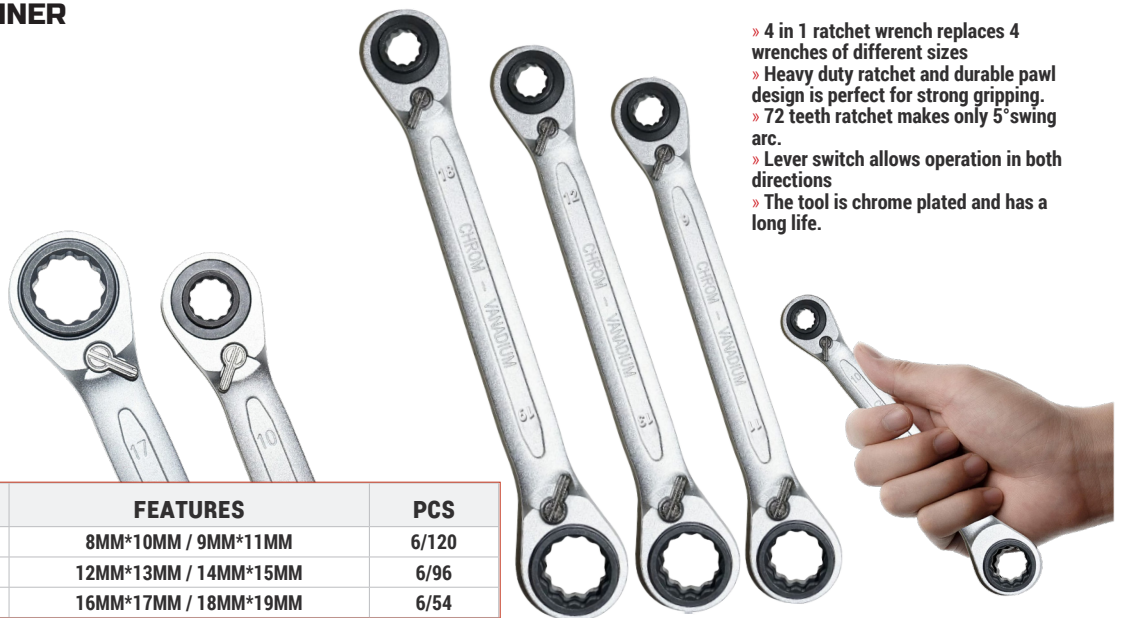

- » 4 in 1 ratchet wrench replaces 4 wrenches of different sizes
- » Heavy duty ratchet and durable pawl design is perfect for strong gripping.
- » 72 teeth ratchet makes only 5° swing arc.
- » Lever switch allows operation in both directions
- » The tool is chrome plated and has a long life.

CODE	FEATURES	PCS
RHT0104110004	8MM*10MM / 9MM*11MM	6/120
RHT0104130004	12MM*13MM / 14MM*15MM	6/96
RHT0104140004	16MM*17MM / 18MM*19MM	6/54



### ALLEN KEY SET (9 PCS)



» 1,5-2-2,5-3-4-5-6-8-10MM

CODE	FEATURES	PCS
RHT050110009	Short	10/80
RHT050110109	Long	10/40

### ALLEN KEY SET (9 PCS)



» T10-T15-T20-T25-T27-T30-T40-T45-T50

CODE	FEATURES	PCS
RHT050110009	Short	10/80
RHT050111109	Long	10/40

### ALLEN KEY SET (9 PCS) EXTRA LONG



» 1,5-2-2,5-3-4-5-6-8-10MM

CODE	FEATURES	PCS
RHT0501141008	Extra Long	10/40

### ALLEN KEY SET (9 PCS) EXTRA LONG

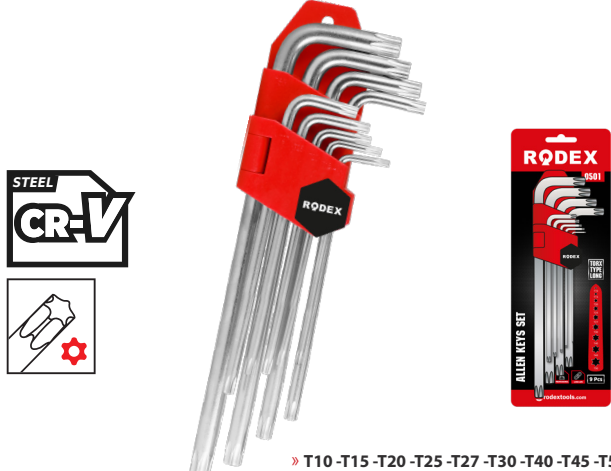

» T10-T15-T20-T25-T27-T30-T40-T45-T50

CODE	FEATURES	PCS
RHT0501140008	Extra Long	10/40

### ALLEN KEY SET (9 PCS)



» 1,5-2-2,5-3-4-5-6-8-10MM

CODE	FEATURES	PCS
RHT0501120008	Short	10/80
RHT0501121008	Long	10/40

### ALLEN KEY SET (9 PCS)



» T10-T15-T20-T25-T27-T30-T40-T45-T50

CODE	FEATURES	PCS
RHT0501130008	Short	10/80
RHT0501131008	Long	10/40



**PRUNING SAW WITH COVER**



- 7 TPI**
- PVC HANDLE**
- WOOD**
- HARDENED TEETH**

CODE	FEATURES	PCS
RHT0702110024	240 mm Small Tooth	6/36
RHT0702110030	300 mm Small Tooth	6/36
RHT0702120030	300 mm Large Tooth	6/36

**PRUNING SAW WITH COVER**



- 7 TPI**
- PVC HANDLE**
- WOOD**
- HARDENED TEETH**
- LARGE TOOTH**

CODE	FEATURES	PCS
RHT0702121030	300 mm Large Tooth	6/36

**FOLDABLE PRUNING SAW**



- 7 TPI**
- PVC HANDLE**
- WOOD**
- HARDENED TEETH**
- LARGE TOOTH**

CODE	FEATURES	PCS
RHT0702100018	180 mm Small Tooth	6/60

**FOLDABLE PRUNING SAW**



- 7 TPI**
- PVC HANDLE**
- WOOD**
- HARDENED TEETH**
- LARGE TOOTH**

CODE	FEATURES	PCS
RHT0702101018	180 mm Small Tooth	6/36

**WALLBOARD SAW**



- 7 TPI**
- PVC HANDLE**
- HARDENED TEETH**
- HIGH STRENGTH STEEL**

CODE	FEATURES	PCS
RHT0704100015	150MM	12/48

**WALLBOARD SAW**



- 7 TPI**
- PVC HANDLE**
- HARDENED TEETH**
- HIGH STRENGTH STEEL**
- DOUBLE EDGED**

CODE	FEATURES	PCS
RHT0704200015	150MM	12/48



### MITRE BOX & BACK SAW



» Miter box + abrasive saw RODEX set is intended for domestic and professional use. The miter box helps to cut workpieces of medium and small thickness from wood, plastic, polyurethane strictly at a certain angle. The saw has small sharp teeth that have undergone additional hardening, ensuring high quality work.

CODE	FEATURES	PCS
RHT0705110030	300 mm 11TPI (Thread Pitch)	1/25

### JIG SAW BLADE



CODE	FEATURES	PCS
RHT0706110118	5 Pcs - 75 mm / T118A	100/400

### JIG SAW BLADE



CODE	FEATURES	PCS
RHT0706100144	5 Pcs - 100 mm / T144D	100/400

### JIG SAW BLADE



CODE	FEATURES	PCS
RHT0706120101	2 Pcs - 76 mm / T101A0	100/400

### JIG SAW BLADE

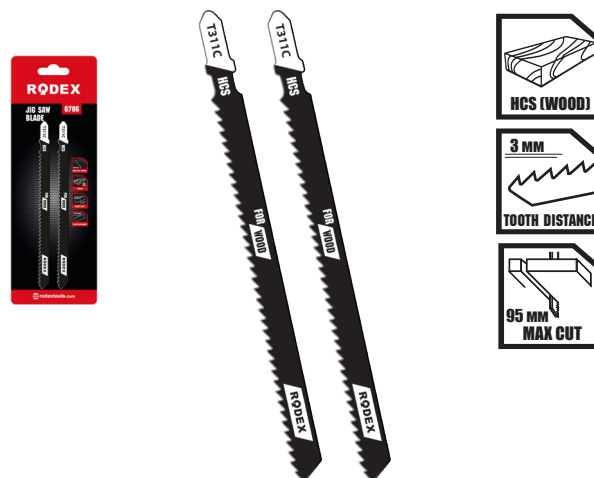

CODE	FEATURES	PCS
RHT0706130311	2 Pcs - 116 mm / T311C	100/400



### 4 PCS CUTTING & SCRAPING SET

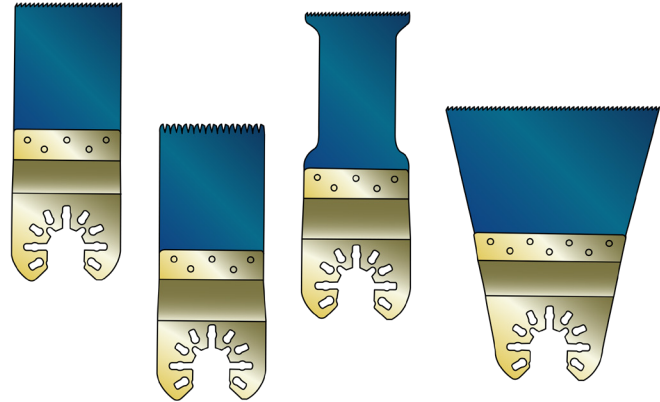

» Nozzles are made of durable bimetal, U8A carbon steel and VK8 hard alloy. They are distinguished by a high working resource, due to which they have a long service life. It is equipped with a universal OIS shaft that fits most restorers.  
 » Attachments are designed to cut, grind and clean materials such as metal, wood, plywood and plastic.

CODE	FEATURES	PCS
RHT1005100004	4 pcs	40

### 17 PCS CUTTING & SCRAPING SET



» Nozzles are made of durable bimetal, U8A carbon steel and VK8 hard alloy. They are distinguished by a high working resource, due to which they have a long service life. It is equipped with a universal OIS shaft that fits most restorers.  
 » Attachments are designed to cut, grind and clean materials such as metal, wood, plywood and plastic.

CODE	FEATURES	PCS
RHT1005110017	17 pcs	20

### ROUTER BITS SET

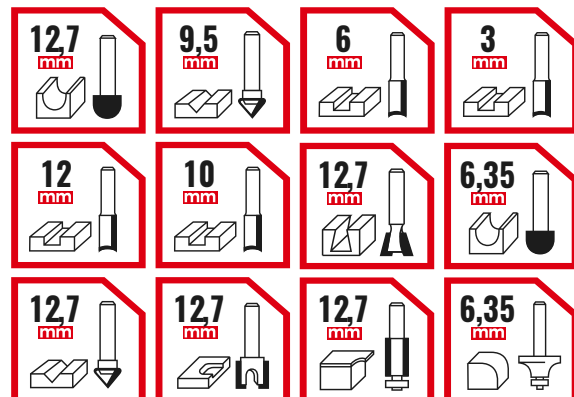

CODE	FEATURES	PCS
RHT0707100812	Shank Diameter 8 mm	20



## HOLE SAW KIT



» Strong Набор кольцевых пил коронок. Материал коронок: Термообработанная инструментальная сталь. Назначение: Используется с дрелями для сверления отверстий в древесине различных пород.

CODE	FEATURES	PCS
RHT1004100008	8 шт / 64 mm - 127 mm	1/20
RHT1004100011	11 шт / 19 mm - 64 mm	1/40
RHT1004100016	16 шт / 19 mm - 127 mm	1/20

## FOLDING UTILITY KNIFE

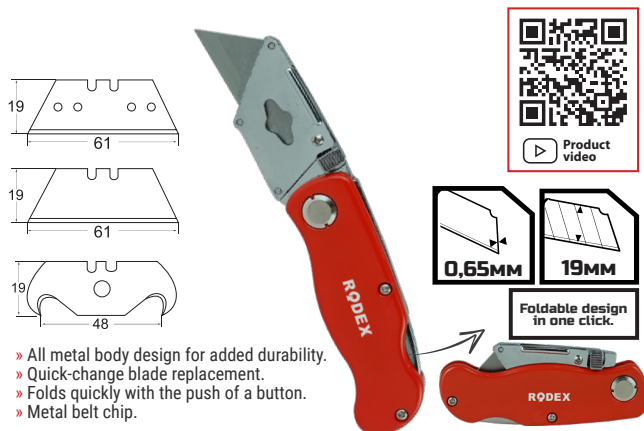

- » All metal body design for added durability.
- » Quick-change blade replacement.
- » Folds quickly with the push of a button.
- » Metal belt clip.

CODE	FEATURES	PCS
RHT0608100001	19mm HOJK	12/72

RHT0608210001	19mm HOJK	10/400
---------------	-----------	--------

## CUTTER BLADE

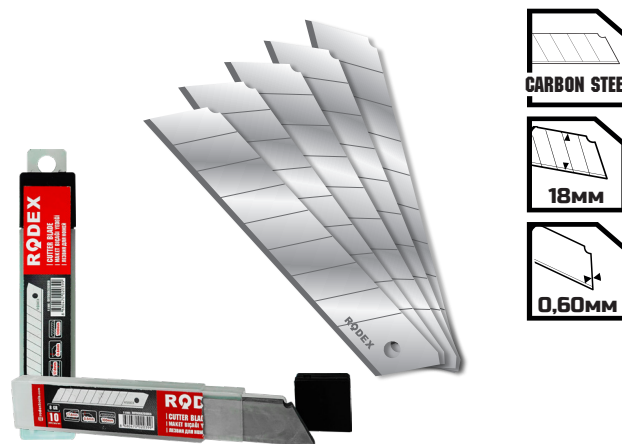

CODE	FEATURES	PCS
RHT0608200008	100x18x 0.6 mm	20/400

## TAP AND DIE SET



- » The tap and die set is designed to obtain clean external and internal threads
- » Taps and dies are made of steel, which is characterized by high contact strength and wear resistance

CODE	FEATURES	PCS
RHT0312100020	20 Pcs.	20

## TAP AND DIE SET



- » The tap and die set is designed to obtain clean external and internal threads
- » Taps and dies are made of steel, which is characterized by high contact strength and wear resistance

CODE	FEATURES	PCS
RHT0312100012	12 Pcs.	20



**VOLTAGE TESTER**



60-230  
VOLT



CODE	FEATURES	PCS
RHT0503100014	75 MM (-)	30/600
RHT0503110014	75 MM (+)	30/600

**SCREWDRIVER SET WITH MAGNETIC TIPS (8 PCS)**

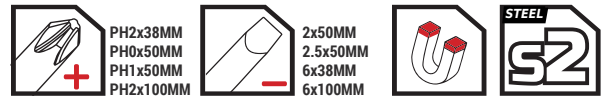

CODE	FEATURES	PCS
RHT0504100008	8 Pcs.	24

**HSS TITANIUM DRILL BIT**

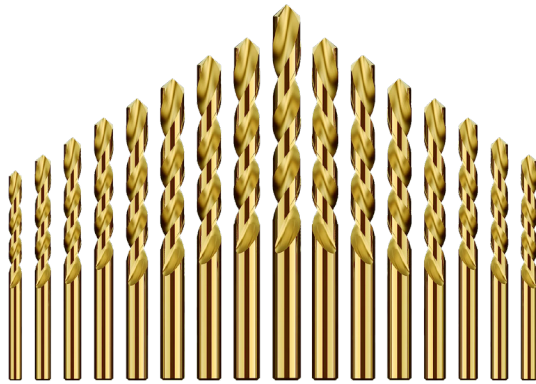

» It is suitable for working with high strength alloy steels and high toughness alloys. The cobalt in its composition allows you to drill aluminum, lead, copper and tin. The 135-degree sharpening angle is perfect for drilling round and smooth surfaces. The special design is designed for precise and accurate drilling of large holes without additional devices. The floor groove serves to quickly remove chips. Reinforced shaft ensures long service life.



CODE	FEATURES	PCS
RHT1001300025	2,50 mm	500
RHT1001300030	3,00 mm	500
RHT1001300040	4,00 mm	500
RHT1001300045	4,50 mm	400
RHT1001300050	5,00 mm	400
RHT1001300055	5,50 mm	500
RHT1001300060	6,00 mm	500
RHT1001300065	6,50 mm	200
RHT1001300075	7,50 mm	200
RHT1001300080	8,00 mm	200
RHT1001300100	10,00 mm	200
RHT1001300120	12,00 mm	200

**SDS PLUS HAMMER DRILL BIT**



CODE	FEATURES	PCS
RHT1001206160	160*6MM	500
RHT1001206210	210*6MM	250
RHT1001208160	160*8MM	250
RHT1001208210	210*8MM	250
RHT1001210210	210*10MM	250
RHT1001210350	350*10MM	200
RHT1001210450	450*10MM	75
RHT1001212160	160*12MM	250
RHT1001212210	210*12MM	250
RHT1001212350	350*12MM	200
RHT1001212450	450*12MM	100

CODE	FEATURES	PCS
RHT1001214350	350*14MM	100
RHT1001214450	450*14MM	100
RHT1001216350	350*16MM	100
RHT1001216450	450*16MM	100
RHT1001218350	350*18MM	50
RHT1001218450	450*18MM	50
RHT1001220350	350*20MM	50
RHT1001220450	450*20MM	50
RHT1001222350	350*22MM	30
RHT1001222450	450*22MM	30
RHT1001224350	350*24MM	30
RHT1001224450	450*24MM	30





### SCREWDRIVER IMPACT BIT



CODE	FEATURES	PCS
RHT1008100065	PH2, 65MM	10/120

### SCREWDRIVER IMPACT BIT



CODE	FEATURES	PCS
RHT1008110065	PH2, 65MM	20/120

### DOUBLE END SCREWDRIVER BITS



2 pcs

CODE	FEATURES	PCS
RHT1008140065	PH2, 65MM	50/400

### SCREWDRIVER IMPACT BIT



2 pcs

CODE	FEATURES	PCS
RHT1008120050	PH2, 50MM	50/400

### DOUBLE END SCREWDRIVER BITS



10 pcs

CODE	FEATURES	PCS
RHT1008150065	PH2, 65MM	20/120

### SCREWDRIVER TORSION BIT



2 pcs

CODE	FEATURES	PCS
RHT1008130050	PH2, 50MM	50/400



**SCREWDRIVER BIT SET**



CODE	FEATURES	PCS
RHT1008400019	18+1	5/80

**MAGNETIC NUT SETTER**



CODE	FEATURES	PCS
RHT1008308048	8x48MM	10/60
RHT1008308065	8x65MM	10/60

**FLAT WOODEN DRILL BITS SET**

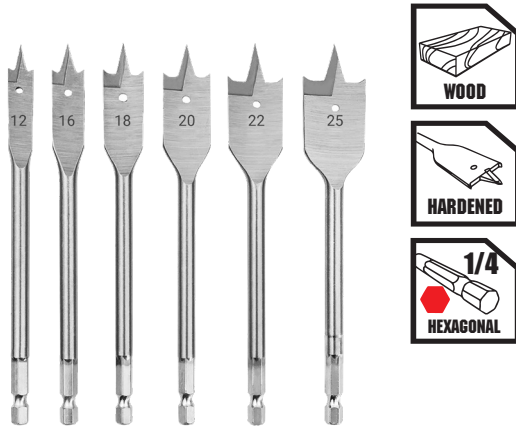

» These drills drill 4 times faster than standard spade drills and last long due to the thicker cutting edge

CODE	FEATURES	PCS
RHT1002100006	6 шт / 12-16-18-20-22-25 мм	25/100

**FLAT WOODEN DRILL BITS**



» These drills drill 4 times faster than standard spade drills and last long due to the thicker cutting edge

CODE	FEATURES	PCS
RHT1002110018	18MM	50/300
RHT1002110020	20MM	50/300
RHT1002110022	22MM	50/300
RHT1002110025	25MM	50/300
RHT1002110032	32MM	50/300

**DOOR LOCK INSTALLATION KIT**

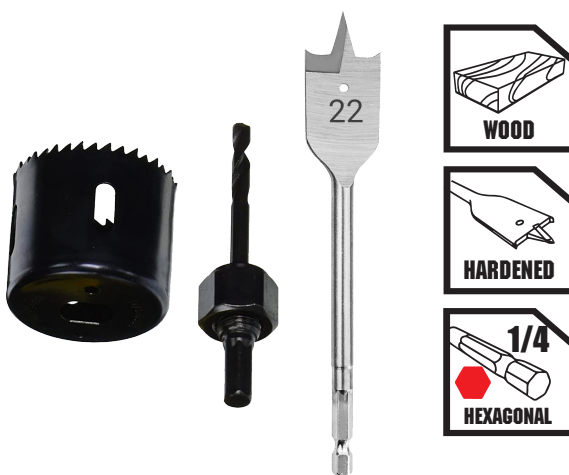

CODE	FEATURES	PCS
RHT1002120048	3	10/60

**GLASS & CERAMIC DRILL BIT**

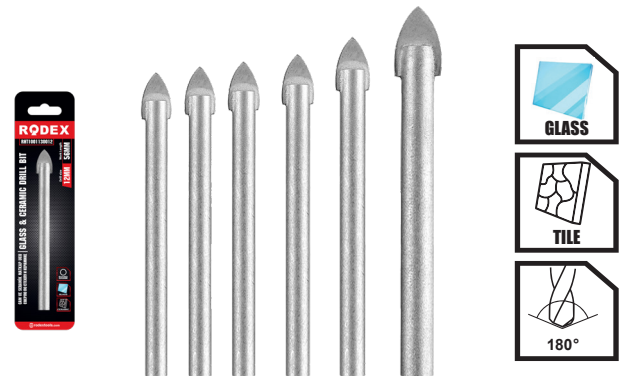

CODE	FEATURES	PCS
RHT1001130004	Diameter 4MM	50/500
RHT1001130005	Diameter 5MM	50/500
RHT1001130006	Diameter 6MM	50/500
RHT1001130008	Diameter 8MM	50/500
RHT1001130010	Diameter 10MM	50/500
RHT1001130012	Diameter 12MM	50/500



### GRINDING BITS STONE SET



» High Working Efficiency: Precision ground for quick and easy sharpening, it has good grinding effect.  
 Application: Suitable for grinding, polishing, carving and burnishing of various , glass, precision equipment and metal.  
 » Shank Diameter: (6mm).

CODE	FEATURES	PCS
RHT1505100005	1/4" (6MM)	20/120

### STEP DRILL



CODE	FEATURES	PCS
RHT1001100412	4-12 MM	50
RHT1001110420	4-20 MM	50
RHT1001120432	4-32 MM	50

### CHISEL SET 3 PIECE SDS MAX

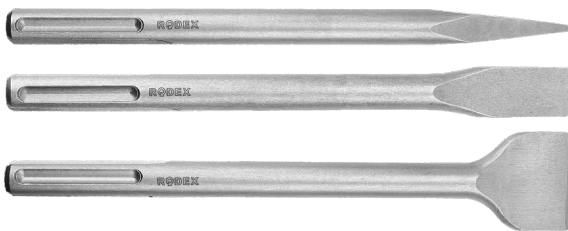

» Chisel Set SDS-MAX for universal removal of material on a larger scale, multiple applications For removal of concrete, bricks, stone and general building materials - Shank type: SDS-Max



CODE	FEATURES	PCS
RHT1102330040	400x18MM	10/50
RHT1102340040	400x18x22MM	5/50
RHT1102350040	400x18x60MM	10/50

### CHISEL SET 3 PIECE SDS PLUS

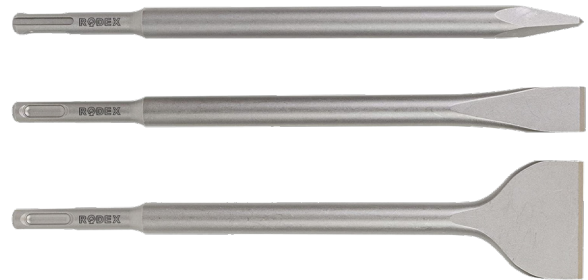

» Chisel Set SDS-Plus for universal removal of material on a larger scale, multiple applications For removal of concrete, bricks, stone and general building materials - Shank type: SDS-Plus



CODE	FEATURES	PCS
RHT1102300025	250x14MM	5/20
RHT1102310025	250x14x22MM	5/20
RHT1102320025	250x14x50MM	50

### CHISEL

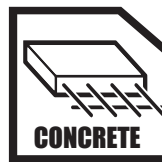

» Sharpened and thickened flat end made of heat treated chrome-vanadium steel CRV steel. With high hardness, high strength, high durability, and resists rust and corrosion.

CODE	FEATURES	PCS
RHT1102100030	300MM*16MM Ring	6/36
RHT1102210030	300MM*16MM Flat	6/36
RHT1102110023	230MM*75MM Wide flat	6/36



**WIRE CUP BRUSH**



- » The wire material is twist knotted steel.
- » Heavy-duty cleaning of large metal surfaces.
- » Easy and smooth removal of burrs, spatter, weld scale, rust, paint and other debris.

CODE	FEATURES	PCS
RHT1502100065	Резьба M14, 65 мм	1/100
RHT1502100075	Резьба M14, 75 мм	1/80
RHT1502100100	Резьба M14, 100 мм	60
RHT1502100125	Резьба M14, 125 мм	40

**WIRE CUP BRUSH**



- » The wire material is crimped brass-plated steel.
- » Heavy-duty cleaning of metal surfaces.
- » Suitable for cleaning work on medium to large steel surfaces, serving also for the removal of corrosion, paint, light deburring, heavy rust or varnish.

CODE	FEATURES	PCS
RHT1502110065	Резьба M14, 65 мм	1/100
RHT1502110075	Резьба M14, 75 мм	1/80
RHT1502110100	Резьба M14, 100 мм	1/60
RHT1502110125	Резьба M14, 125 мм	40

**WIRE BRUSH**



- » The wire material is brass, upper head is steel wire. Handle is PP.
- » Cleans places where strong scrubbing is needed, it helps to remove the welding slag, rust, paint stains, and can clean steel parts, machinery, unfinished metal parts.

CODE	FEATURES	PCS
RHT1501100001	9" 240 мм	12/120

**WIRE BRUSH**



- » The wire material is brass, upper head is steel wire. Handle is rubber coated PP.
- » The brass brush is ideal to clean metal surfaces without scratching them, while the steel wire brush is for rust removal.

CODE	FEATURES	PCS
RHT1501110001	8" 200 мм	12/120

**TILE CUTTING MACHINE WITH INFRARED**

- » Solid I-shaped slide rail, provides precise and smooth cut
- » Durable and replaceable tungsten carbide cutting wheel
- » Movable shock-resistant support feet
- » Precise adjustable measuring scale
- » Anti-slip rubber surface, prevents the tiles moving while cutting.



CODE	FEATURES	PCS
RHT1301120060	600 мм "With Laser"	3
RHT1301120080	800 мм "With Laser"	2
RHT1301120100	1000 мм "With Laser"	2



### F-CLAMP HEAVY DUTY

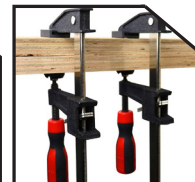

» Столярная F-образная струбцина используется в столярном, слесарном и плотницком деле и позволяет фиксировать заготовки из металла, древесины, пластика и других материалов для их соединения, обработки, склеивания, шлифовки, сверления и пр. Штанга из высококачественной стали А3 и толщиной 5 мм устойчива к деформации и прослужит долго. Диаметр резьбового стержня 12 мм. Максимальное усилие зажима 2000 Н. Эргономичная, двухкомпонентная рукоятка удобно лежит в руке и обеспечивая комфорт во время работы.

CODE	FEATURES	PCS
RHT1203100040	400 MM	10
RHT1203100050	500 MM	10
RHT1203100060	600 MM	10
RHT1203100080	800 MM	5
RHT1203100100	1000 MM	5

### QUICK RATCHET BAR CLAMP



CODE	FEATURES	PCS
RHT1204100040	150 MM	36
RHT1204100050	200 MM	36
RHT1204100060	300 MM	36
RHT1204100080	450 MM	24
RHT1204100100	600 MM	24

### SPRING CLAMP



CODE	FEATURES	PCS
RHT1205100040	50 MM	1000
RHT1205100060	75 MM	600
RHT1205100080	100 MM	200
RHT1205100100	150 MM	100

### WOODEN CHISEL SET



CODE	FEATURES	PCS
RHT1101200003	12-16-18 MM	6/48

### WOODEN CHISEL



CODE	FEATURES	PCS
RHT1101100016	16 MM	6/60
RHT1101100018	18 MM	6/60
RHT1101100020	20 MM	6/60
RHT1101100024	24 MM	6/60



**SAFETY GOGGLES**



- » Panoramic glass has a double-sided coating
- » The outer hard layer is resistant to abrasion and scratching, the inner one is resistant to splashes of solutions and caustic substances
- » The frame is made of soft and elastic evoprene material
- » The glasses are well ventilated and do not fog

CODE	FEATURES	PCS
RHT1811100001	Transparent	200

**SAFETY GOGGLES**



- » Panoramic glass has a double-sided coating
- » The outer hard layer is resistant to abrasion and scratching, the inner one is resistant to splashes of solutions and caustic substances
- » The frame is made of soft and elastic evoprene material
- » The glasses are well ventilated and do not fog

CODE	FEATURES	PCS
RHT1811100002	Black	200

**SAFETY GOGGLES**



- » Panoramic glass has a double-sided coating
- » The outer hard layer is resistant to abrasion and scratching, the inner one is resistant to splashes of solutions and caustic substances
- » The frame is made of soft and elastic evoprene material
- » The glasses are well ventilated and do not fog

CODE	FEATURES	PCS
RHT1811100003	Red	200

**SAFETY GOGGLES**



- » Panoramic glass has a double-sided coating
- » The outer hard layer is resistant to abrasion and scratching, the inner one is resistant to splashes of solutions and caustic substances
- » The frame is made of soft and elastic evoprene material
- » The glasses are well ventilated and do not fog

CODE	FEATURES	PCS
RHT1811100004	Blue	200

**SAFETY GOGGLES**



- » Panoramic glass has a double-sided coating
- » The outer hard layer is resistant to abrasion and scratching, the inner one is resistant to splashes of solutions and caustic substances
- » The frame is made of soft and elastic evoprene material
- » The glasses are well ventilated and do not fog

CODE	FEATURES	PCS
RHT1811100005	Black	200



**RQDEX**



### AUTO DARKENING WELDING HELMET



- » Lens power control: Automatic
- » Filter: Impact-resistant plastic with 90\*35mm actual viewing area
- » Helmet material: PP (Fireproofing)
- » Shade control: DIN 4 / DIN 11
- » Switching time: Light to dark: 1/25000sec. Dark to light: 0.4sec.
- » UV-IR Protection: Up to shade DIN 15 at all time
- » Power supply: Solar cells battery + 1 CR2032 Lithium battery (not replaceable)

CODE	FEATURES	PCS
RHT1809110001	Auto Darkening	1/20

### AUTO DARKENING WELDING HELMET



- » Lens power control: Automatic
- » Filter: Impact-resistant plastic with 93\*43mm actual viewing area
- » Helmet material: PP (Fireproofing)
- » Shade control with External Knob: DIN 4 (Grind Mode) / DIN 9-13 (Weld Mode)
- » Sensitivity control and delay time control with a knob.
- » Switching time: Light to dark: 1/25000sec. Dark to light: 0.1-1.0sec.
- » UV-IR Protection: Up to shade DIN 16 at all time
- » Power supply: Solar cells battery + 1 CR2032 Lithium battery (replaceable)

CODE	FEATURES	PCS
RHT1809120001	Auto Darkening	1/20

### AUTO DARKENING WELDING HELMET



- » Lens power control: Automatic
- » Filter: Impact-resistant plastic with 90\*32mm actual viewing area
- » Helmet material: PP (Fireproofing)
- » Shade control: DIN 4 / DIN 11
- » Switching time: Light to dark: 1/20000sec. Dark to light: 0.4sec.
- » UV-IR Protection: Up to shade DIN 15 at all time
- » Power supply: Solar cells battery + 1 CR1025 Lithium battery (not replaceable)

CODE	FEATURES	PCS
RHT1809100001	Auto Darkening	1/24

### AUTO DARKENING WELDING GOGGLES



- » Better clarity, True color viewing, The welding goggles automatically changes from a bright state to a dark state when an arc is generated, and returns to a bright state when the welding stops, providing each worker with a clear view to release their hands.

КОД	ХАРАКТЕРИСТИКА	ШТ/КОР
RHT1809130001	АВТОЗАТЕМНЕНИЕМ	1/100

### WELDING MAGNET



CODE	FEATURES	PCS
RHT0409110025	4-12 KG	12/72
RHT0409110050	4-22 KG	8/48
RHT0409110075	4-33 KG	6/24

### WELDING MAGNET SET

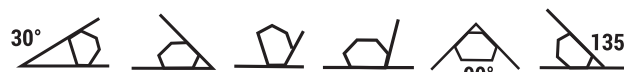
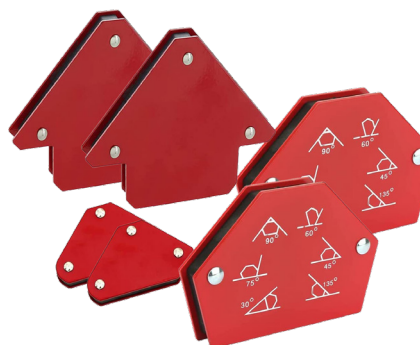

CODE	FEATURES	PCS
RHT0409100006	6 Pcs / 4-12 Kg	10



**MINI PAINT ROLLER SET OF 4PCS**

**4 PCS**

- 1- Roll 10cm
- 2- Additional roll 10cm
- 3- Brush 1.5"
- 4- Black tray



CODE	FEATURES	PCS
RHT2106100004	4 pcs	30

**PAINT ROLLER SET OF 3PCS**

**3 PCS**

- 1- Roll 23cm
- 2- Cover 10m<sup>2</sup> of rust
- 3- 9" Black Tray



CODE	FEATURES	PCS
RHT2106200003	3 pcs	12

**PAINT ROLLER SET OF 4PCS**

**4 PCS**

- 1- Roll 23cm
- 2- Brush 2" (50.8 mm)
- 3- Cover 10m<sup>2</sup> of rust
- 4- 9" Black Tray



CODE	FEATURES	PCS
RHT2106210004	4 pcs	12

**PAINT ROLLER SET OF 5PCS**

**5 PCS**

- 1- Roll 23cm
- 2- Brush 10cm
- 3- Brush 2" (50.8 mm)
- 4- Cover 10m<sup>2</sup> of rust
- 5- 9" Black tray



CODE	FEATURES	PCS
RHT2106220005	5 pcs	12

**SPRAY GUN**



- » Nozzle diameter, 1,8 mm
- » Connection type, quick coupler (EURO)
- » Air consumption, 200 l/min
- » Air inlet diameter, 1/4"

CODE	FEATURES	PCS
RHT1401100100	Capacity , 1.0 lt	1/10

**SPRAY GUN**



- » Nozzle diameter, 1,8 mm
- » Connection type, quick coupler (EURO)
- » Air consumption, 200 l/min
- » Air inlet diameter, 1/4"

CODE	FEATURES	PCS
RHT1401110060	Capacity , 0.6 lt	1/20



## SPRAY GUN



- » Nozzle diameter, 1,8 mm
- » Connection type, quick coupler (EURO)
- » Air consumption, 200 l/min
- » Air inlet diameter, 1/4"

CODE	FEATURES	PCS
RHT1401120060	Capacity , 0.6 lt	1/20

## SPRAY GUN



- » Connection type, quick coupler (EURO)
- » Air consumption, 200 l/min
- » Air inlet diameter, 1/4"

CODE	FEATURES	PCS
RHT1401130600	Capacity , 6.0 lt	1/8

## AIR BLOW GUN



- » Pressure, 7,9 atm
- » Air consumption, 250 l/min
- » Air inlet diameter, 1/4 "
- » Metal gun body – for a long service life

CODE	FEATURES	PCS
RHT1402100001	Nose Length 30 mm	10/50

## AIR BLOW GUN



- » Pressure, 7,9 atm
- » Air consumption, 250 l/min
- » Air inlet diameter, 1/4 "
- » Metal gun body – for a long service life

CODE	FEATURES	PCS
RHT1402100002	Nose Length 100 mm	10/50

## DEGREASING & UNDERCOATING GUN



- » Working pressure, 3.5 atm
- » Capability to work for a long time without stopping
- » Reliable metal case
- » Light weight for convenience of work



CODE	FEATURES	PCS
RHT1403100001	Capacity , 0.6 lt	2/20

## FOAM GUN



- » PTFE non-stick coated basket, needle and ball valve promote unrestricted flow of the foam gun applicator.
- » RODEX Foam Gun works as a Great Stuff Dispensing Gun and is perfect for use with the Gaps & Cracks, Window & Door, Wall & Floor Construction Adhesive, Enerfoam, Pestblock, and Cleaner.

CODE	FEATURES	PCS
RHT1407100001	Chroma Plated	20



MEASURING TAPE



- » Sliding lock design with pull button release allows inner tape extended and retracted smoothly.
- » Suitable for construction, decoration, drawing and other necessary tools for household measurement.

CODE	FEATURES	PCS
RHT0901140316	3M*16MM	12/120
RHT0901140519	5M*19MM	12/120
RHT0901140525	5M*25MM	12/120
RHT0901140725	7.5M*25MM	8/48
RHT0901140102	10M*25MM	8/48

MEASURING TAPE



Equipped with automatic stop function.



Double-sided tape nylon coated steel.



A magnet is built into the tape measure to secure it to metal surfaces.

- » ABS plastic makes the body of the tool resistant to impacts and damage when dropped from a small height, and its ergonomic shape fits comfortably in the hand.

CODE	FEATURES	PCS
RHT0901190316	3M*16MM	12/180
RHT0901190525	5M*25MM	12/120
RHT0901190725	7.5M*25MM	6/60
RHT0901190102	10M*25MM	6/60

MEASURING TAPE



- » Self-locking function, automatic recycling at the push of a button, press and stop, safe and secure.
- » Suitable for construction, decoration, drawing and other necessary tools for household measurement.

CODE	FEATURES	PCS
RHT0901160316	3M*16MM	12/180
RHT0901160519	5M*19MM	12/120
RHT0901160525	5M*25MM	12/120
RHT0901160102	10M*25MM	6/60

MEASURING TAPE



Double-sided tape nylon coated steel.



A magnet is built into the tape measure to secure it to metal surfaces.

- » The rubber cover on the case prevents it from being damaged in the event of a drop and from accidentally slipping out of the user's hand.

CODE	FEATURES	PCS
RHT0901170316	3M*16MM	12/180
RHT0901170525	5M*25MM	12/120
RHT0901170725	7.5M*25MM	6/60

MEASURING TAPE



Equipped with automatic stop function.



Double-sided tape nylon coated steel.



A magnet is built into the tape measure to secure it to metal surfaces.

- » The rubber cover on the case prevents it from being damaged in the event of a drop and from accidentally slipping out of the user's hand.

CODE	FEATURES	PCS
RHT0901180316	3M*16MM	12/180
RHT0901180525	5M*25MM	12/120
RHT0901180725	7.5M*25MM	6/60
RHT0901180102	10M*25MM	6/60

MEASURING TAPE



- » Self-locking function, automatic recycling at the push of a button, automatic stop, safe and secure.
- » Suitable for construction, decoration, drawing and other necessary tools for household measurement.

CODE	FEATURES	PCS
RHT0901150316	3M*16MM	12/240
RHT0901150519	5M*19MM	12/120
RHT0901150725	7.5M*25MM	12/48
RHT0901150102	10M*25MM	8/48



### LONG STEEL MEASURING TAPE



- » Impact-resistant heavy duty ABS frame
- » Nylon coated reinforced tape for maximum durability
- » Open reel stainless steel tape
- » Cone tip stake for accurate measurements and stability

CODE	FEATURES	PCS
RHT0902100030	30M*25MM	1/10
RHT0902100050	50M*25MM	1/10

### CHALK LINE REEL



CODE	FEATURES	PCS
RHT0909100050	50 gr POWDER / 50M	6/120
RHT0909110115	115 gr POWDER / 50M	6/60

### RULER

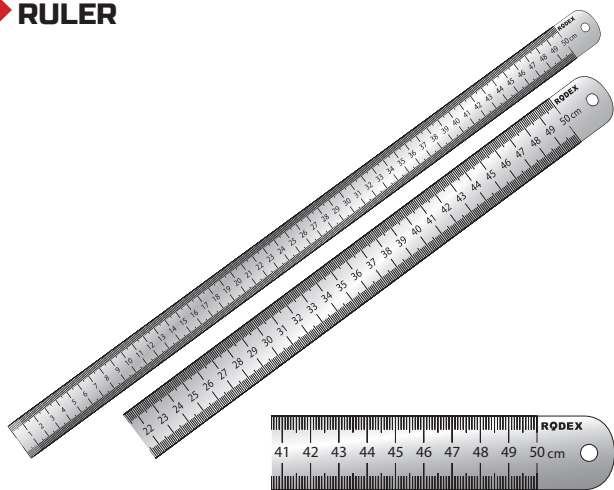

CODE	FEATURES	PCS
RHT0907100050	500MM	12/300
RHT0907100100	1000MM	12/120

### L TYPE RULER HEAVY DUTY



CODE	FEATURES	PCS
RHT0906100025	250MM	60
RHT0906100030	300MM	60
RHT0906100040	400MM	60
RHT0906100050	500MM	60

### ALUMINIUM "L" RULER WITH LEVEL BUBBLE

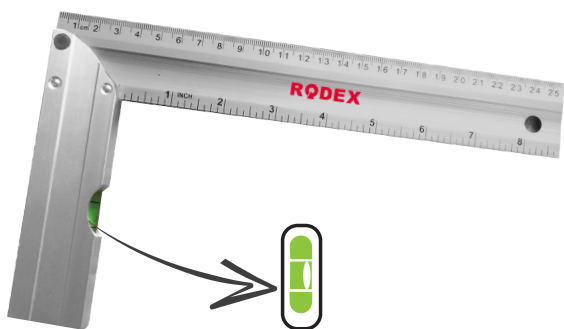

CODE	FEATURES	PCS
RHT0906110025	250MM	60
RHT0906110030	300MM	60
RHT0906110035	350MM	60
RHT0906110040	400MM	60
RHT0906110050	500MM	60
RHT0906110060	600MM	60

### TRIPOD



1/4"  
SCREW MOUNT

CODE	FEATURES	PCS
RHT0908130012	1.2 M	30



## LASER DISTANCE MEASURER

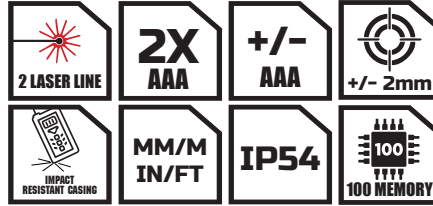
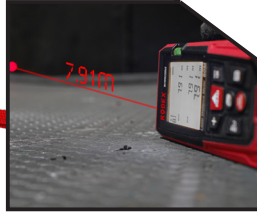

Carrying bag for easy storage and transportation.

CODE	FEATURES	PCS
RHT0903120040	40 M	1/25
RHT0903120060	60 M	1/25
RHT0903120080	80 M	1/25
RHT0903120100	100 M	1/25



## LASER DISTANCE MEASURER

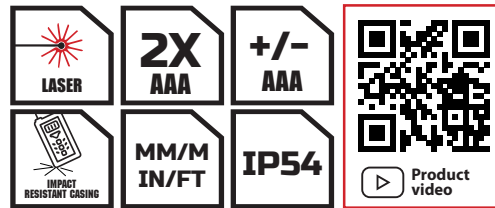

CODE	FEATURES	PCS
RHT0903100040	40 M	1/60
RHT0903100060	60 M	1/60
RHT0903100080	80 M	1/60
RHT0903100100	100 M	1/60



## 4D 16 LINE LASER LEVEL



- » Self leveling system.
- » Can be used in indoor and outdoor works.
- » 4 laser diodes with a wavelength of 532 nm.
- » Less than 1W energy consumption.
- » High level of accuracy.
- » Protection against dust and moisture: IP54;
- » Easy to store and carry with its storage bag.
- » Working time on a single charge: 3-4 hours.
- » Can be mounted on a 1/4" threaded tripod.



CODE	FEATURES	PCS
RHT0908140416	20-30 m, 16 Line	1/10





## 4D - 16 LINE LASER LEVEL



- » Fast automatic leveling;
- » Indoor/outdoor function;
- » 4 laser diodes with a wavelength of 532 nm;
- » Laser power less than 1 mW;
- » High level of accuracy;
- » Protection against dust and moisture: IP54;
- » Case - for easy storage and transportation of the device.
- » Working time on a single charge is 3-4 hours
- » Can be mounted on a tripod with 1/4" thread



CODE	FEATURES	PCS
RHT0908170416	20m, 16 Line	1/10



## 5 LINE LASER LEVEL

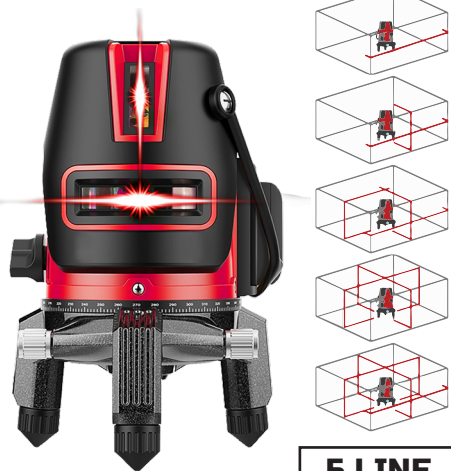

**5 LINE**

» Can be mounted on a 1/4" threaded tripod.

CODE	FEATURES	PCS
RHT0908100520	10-20m, 5 Line	12

## 5 LINE LASER LEVEL

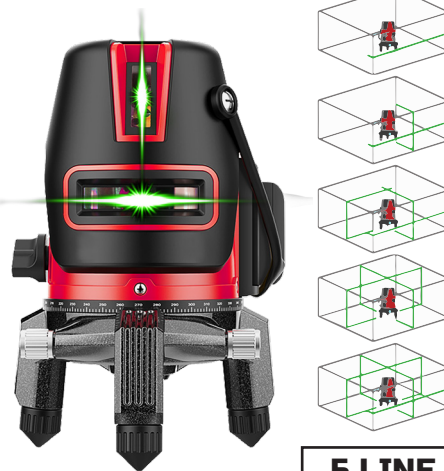

**5 LINE**

» Can be mounted on a 1/4" threaded tripod.

CODE	FEATURES	PCS
RHT0908110530	15-30m, 5 Line	1/20

## 5 LINE LASER LEVEL

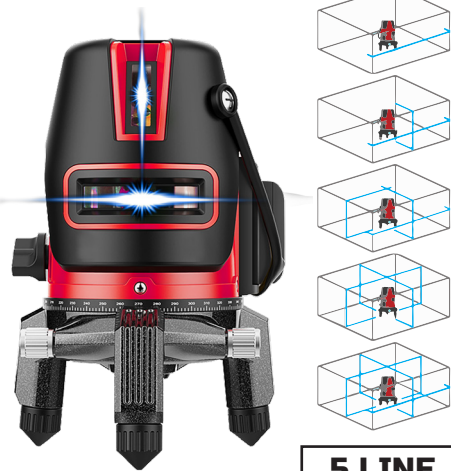

**5 LINE**

» Can be mounted on a 1/4" threaded tripod.

CODE	FEATURES	PCS
RHT0908120535	20-35m, 5 Line	12

## 2 LINE LASER LEVEL



**2 LINE**

» Can be mounted on a 1/4" threaded tripod.

CODE	FEATURES	PCS
RHT0908150225	15m, 2 Line	1/20



### SPIRIT LEVEL ALUMINIUM



- » Professional spirit level for easy leveling: horizontal accuracy at 180°, vertical accuracy at 90°, and 45° accuracy – all with a high level of precision: ±0.5mm/m
- » Shock-absorbing end caps of the torpedo level hold up to heavy use
- » Aluminum frame provides long-lasting strength
- » Powerful magnetic and milled edge for convenient, hands-free use

CODE	FEATURES	PCS
RHT0904140040	400MM	30
RHT0904140050	500MM	30
RHT0904140060	600MM	30
RHT0904140080	800MM	30
RHT0904140100	1000MM	30



### SPIRIT LEVEL ALUMINIUM



CODE	FEATURES	PCS
RHT0904110050	500MM	60
RHT0904110060	600MM	60
RHT0904110080	800MM	30
RHT0904110100	1000MM	30

### SPIRIT LEVEL ALUMINIUM



CODE	FEATURES	PCS
RHT0904150040	400MM	50
RHT0904150060	600MM	50
RHT0904150080	800MM	50
RHT0904150100	1000MM	50

### MINI SPIRIT LEVEL

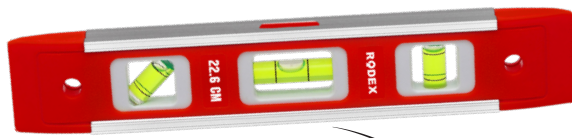

» Three eyes on the body of the 226 mm RODEX plastic magnetic scale provide the opportunity to check surfaces in three different positions: horizontally, vertically and at a 45° angle.

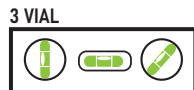

CODE	FEATURES	PCS
RHT0904160023	22,6 cm	120

### MINI SPIRIT LEVEL



CODE	FEATURES	PCS
RHT0904130001	85 * 20 * 45.5MM	20/160



### PLASTIC LEVEL WITH MAGNET

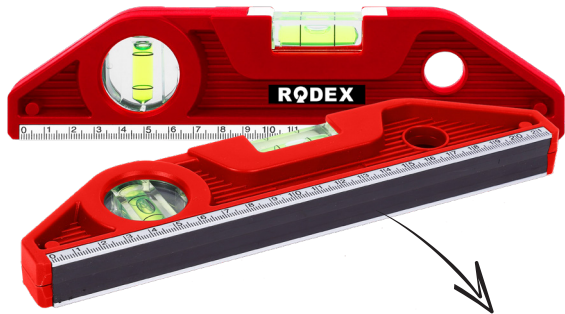

CODE	FEATURES	PCS
RHT0904180021	21 cm	60

### MAGNETIC BASE SPIRIT LEVEL

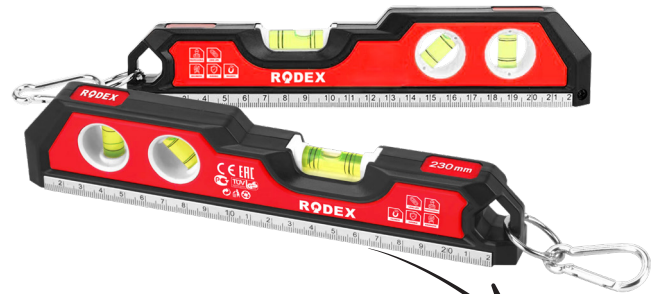

» The rubber cover on the case prevents it from being damaged in the event of a drop and from accidentally slipping out of the user's hand.

CODE	FEATURES	PCS
RHT0904190023	22 cm	60

### ALUMINUM TRIANGLE RULER



» Aluminum triangular ruler RODEX is a useful and practical tool essential for the construction of houses and roof installation, as well as for domestic use. The tool is made of durable aluminum. It has a laser-engraved measurement scale that does not erase during use.

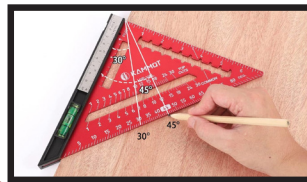

CODE	FEATURES	PCS
RHT0906120017	Side Length / 184.2 MM Short Side Length / 175 MM	60

### COMBINATION SQUARE RULER

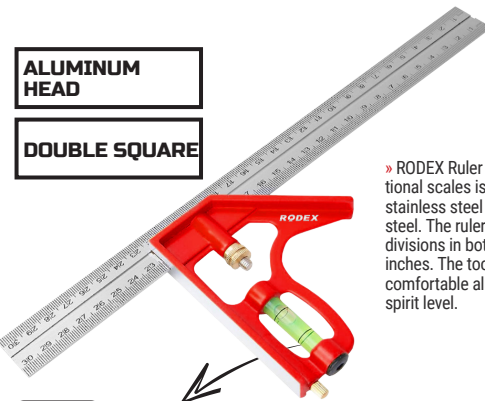

ALUMINUM HEAD  
DOUBLE SQUARE

» RODEX Ruler with multifunctional scales is made of 30 cm stainless steel 72-125 stainless steel. The ruler is equipped with divisions in both centimeters and inches. The tool is equipped with a comfortable aluminum handle and spirit level.



CODE	FEATURES	PCS
RHT0904200030	300 MM	50

### PALLET JACK

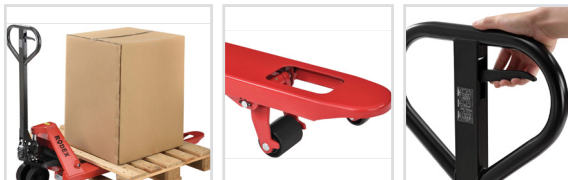

Trolley type - hydraulic  
Load capacity - 2500 kg  
Lifting height (min) 90 mm  
Lifting height (max.) 207 mm  
Distance between forks 550 mm  
Forks 1130 mm  
Wheel material / polyurethane  
Roll diameter 80x70 mm  
Roll material / polyurethane  
Total width / 574 mm  
Net weight / 69.4 kg

**2500 KG**

CODE	FEATURES	PCS
RHT1705100025	2500 kg Load Capacity	6
RHT1706100001	2 big, 4 Small Wheels / Wheels 6 pcs. Wheeled Roller	1





**STAPLER GUN**

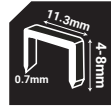
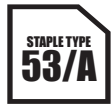

CODE	FEATURES	PCS
RHT1601110468	Wire Width 0.7 mm	12/48

**STAPLER GUN**

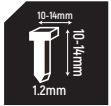
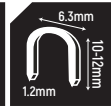
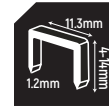
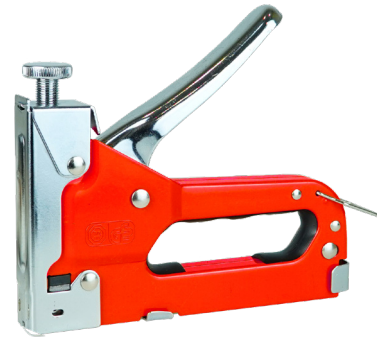

CODE	FEATURES	PCS
RHT1601100414	Wire Width 1.2 mm	6/24

**STAPLER GUN**

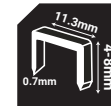

CODE	FEATURES	PCS
RHT1601130468	Wire Width 0.7 mm	10/60

**STAPLER GUN**



CODE	FEATURES	PCS
RHT1601120468	Wire Width 0.7 mm	10/60

**STAPLES**

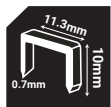
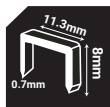
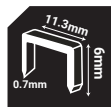
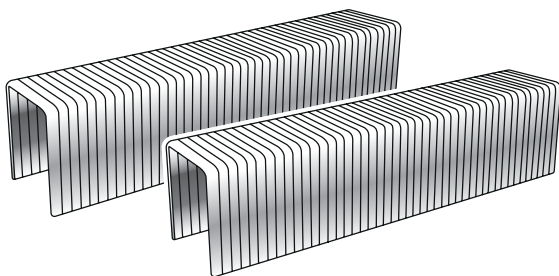

CODE	FEATURES	PCS
RHT1602100006	6 mm - J/53	1000/200.000
RHT1602100008	8 mm - J/53	1000/200.000
RHT1602100010	10 mm - J/53	1000/200.000

**DRYWALL SCREW**

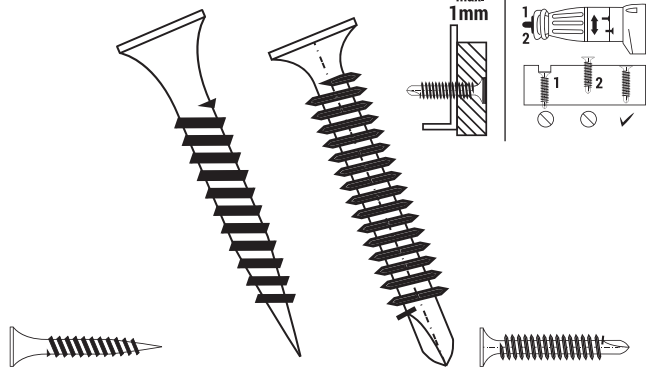

CODE	FEATURES	PCS	CODE	FEATURES	PCS
RHT14103525	3.5×25MM	1000	RHT14203525	3.5×25MM	1000
RHT14103530	3.5×25MM	1000	RHT14203530	3.5×25MM	1000
RHT14103535	3.5×30MM	1000	RHT14203535	3.5×30MM	1000
RHT14103545	3.5×45MM	1000	RHT14203545	3.5×45MM	1000
RHT14103550	3.5×50MM	1000	RHT14203550	3.5×50MM	1000



## HAMMER WITH WOODEN HANDLE



CODE	FEATURES	PCS
RHT0801100010	100 Gr	12/120
RHT0801100020	200 Gr	12/72
RHT0801100030	300 Gr	12/60
RHT0801100050	500 Gr	6/48
RHT0801100080	800 Gr	6/24
RHT0801100100	1000 Gr	6/24
RHT0801100150	1500 Gr	6/12
RHT0801100200	2000 Gr	6/12

## FORGED CLAW HAMMER



- » Full-fledged casting steel
- » Long lifetime even under difficult conditions

CODE	FEATURES	PCS
RHT0802100016	16 OZ (454 Gr)	6/36
RHT0802100020	20 OZ (567 Gr)	6/24

## FORGED CLAW HAMMER



- » Fiberglass Non Slip Shock Reduction Grip. This straight rip claw hammer comes with forged steel head for superior strength and durability, providing you a good hammering experience.

CODE	FEATURES	PCS
RHT0802120008	8 OZ (227rp)	6/48
RHT0802120016	16 OZ (454rp)	6/36
RHT0802120020	20 OZ (567rp)	6/24

## FORGED STRAIGHT JAW CLAW HAMMER



- » Full-fledged casting steel
- » Long lifetime even under difficult conditions

CODE	FEATURES	PCS
RHT0802110016	16 OZ (454 Gr)	6/36
RHT0802110020	20 OZ (567 Gr)	6/24

## MINI CLAW HAMMER



- » Made from high density carbon steel, anti-rust and durable
- » Ergonomic, non-slip, soft rubber, fiber handle
- » Perfect size, easy to carry, convenient for work
- » Ideal for woodworking, DIY Projects, either at home or workshop

CODE	FEATURES	PCS
RHT0802130008	8 OZ (226 Gr)	6/48

## ROOFING HAMMER



- » It is used in roofing works with thin sheet metal
- » Suitable for trimming roof edges and fixing to roof frame.
- » Also Ideal claw hammer for driving nails, ripping out nails, wood work, framing, and punching holes in drywall and shingles
- » Features a pointed rip claw to pull nails and puncture holes in sheet metal and other materials
- » Fiberglass handle is immersed in non-slip rubberized grip
- » Head includes a cut-out and magnet to start nails safely with a quick tap

CODE	FEATURES	PCS
RHT0803100020	20 OZ (567 Gr)	6/24



**WELDERS CHIPPING HAMMER**



» High carbon steel chipping hammer's spring handle is designed to absorb the shock of contact while cleaning welding debris.  
 » One end is a flat chisel and the other end is a conical chisel to get into tight spots. Used for removing slag and welding residue.

CODE	FEATURES	PCS
RHT0804100050	18 OZ (500 Gr)	6/48

**STONE HAMMER**

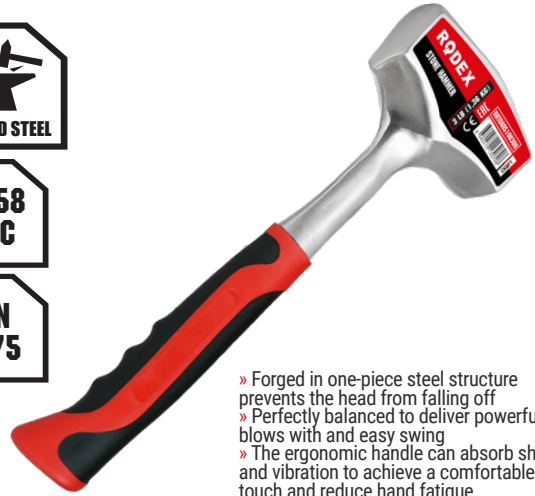

» Forged in one-piece steel structure prevents the head from falling off  
 » Perfectly balanced to deliver powerful blows with an easy swing  
 » The ergonomic handle can absorb shock and vibration to achieve a comfortable touch and reduce hand fatigue

CODE	FEATURES	PCS
RHT0805100300	3.0 LB (1.36 Kg)	6/12

**AXE WITH FIBERGLASS HANDLE**



» Forged and crafted from a single piece of solid steel for a durable and long lasting use  
 » Can be used perfectly for chopping logs, small trees & branches or splitting firewood & kindling  
 » Shock absorbing fiberglass handle which will reduce the strain on your hand, resists slipping and adds comfort

CODE	FEATURES	PCS
RHT0808100020	20 OZ (567 Gr)	6/24

**AXE WITH FIBERGLASS HANDLE**



» Forged carbon steel heat treated blade provides smooth, sharp and quick splits and stays sharp long.  
 » Can be used perfectly for chopping logs, small trees & branches or splitting firewood & kindling  
 » Shock absorbing fiberglass handle which will reduce the strain on your hand, resists slipping and adds comfort

CODE	FEATURES	PCS
RHT0808110150	1500 Gr	12

**HEAVY DUTY FLAT WRECKING BAR**



CODE	FEATURES	PCS
RHT0810100040	400 MM	24
RHT0810100045	450 MM	24
RHT0810100060	600 MM	12
RHT0810100075	750 MM	12
RHT0810100090	900 MM	10

**OVAL SHAPE SHARPENING STONE**

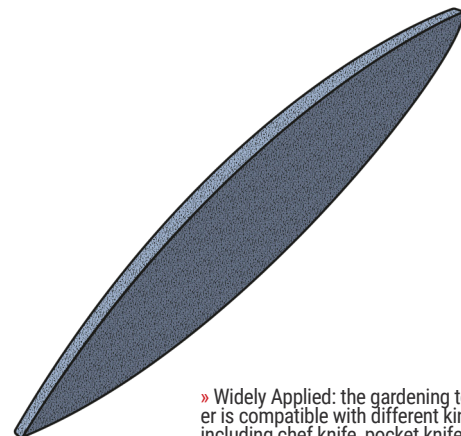

» Widely Applied: the gardening tool sharpener is compatible with different kinds of knives, including chef knife, pocket knife, butcher knife, paring knife, BBQ knife, scissor, chisel, blade and so on.

CODE	FEATURES	PCS
RHT1104100010	229MM	100



### PRODUCT STAND

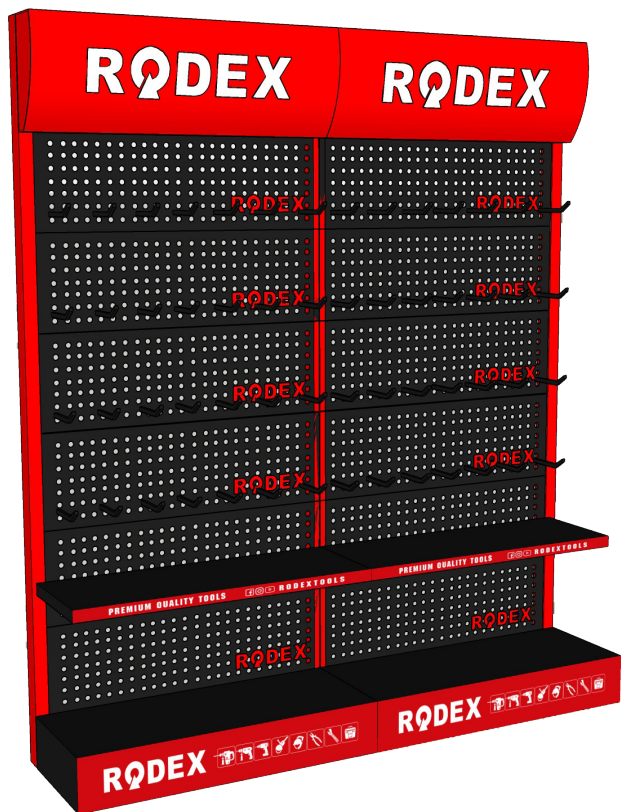

CODE	FEATURES	PCS
RHT2501100001	100x220x40cm	3 Sets
RHT2501100002	200x220x40cm	1 Sets

### Tool Bag

**600D**  
POLYESTER **14"**



CODE	FEATURES	PCS
RHT1906100001	34*22*25 cm	25

### Tool Belt

**600D**  
POLYESTER



CODE	FEATURES	PCS
RHT1906110001	13*23 cm	50

### Tool Belt

**600D**  
POLYESTER



CODE	FEATURES	PCS
RHT1906120001	25*15 cm	100

### Tool Belt

**600D**  
POLYESTER



CODE	FEATURES	PCS
RHT1906130001	56*16 cm	50



### WHELLS TOOL BOX



CODE	FEATURES	PCS
OTCK028	380 x 595 x 420MM	1/2

### ECO WHELLS TOOL BOX BLACK



CODE	FEATURES	PCS
OTCKP028	380 x 595 x 420MM	1/2

### PORTABLE COVER TOOL BOX



CODE	FEATURES	PCS
OTYN015	15"	1/6
OTYN018	18"	1/6

### JUMBO METAL GRIPPED PLASTIC TOOL BOX



CODE	FEATURES	PCS
OTCM113	13"	1/6
OTCM116	16"	1/6
OTCM119	19"	1/6
OTCM122	22"	1/6

### METAL GRIPPED PLASTIC TOOL BOX



CODE	FEATURES	PCS
OTCM013	13"	1/6
OTCM016	16"	1/6
OTCM019	19"	1/6
OTCM022	22"	1/6

### GRIP METAL GRIPPED TOOL BOX



CODE	FEATURES	PCS
OTCMG13	13"	1/6
OTCMG16	16"	1/8
OTCMG19	19"	1/8
OTCMG22	22"	1/6



### GRIP PLASTIC GRIPPED TOOL BOX



CODE	FEATURES	PCS
OTCMGP13	13"	1/6
OTCMGP16	16"	1/8
OTCMGP19	19"	1/8
OTCMGP22	22"	1/6

### CLASSIC PLASTIC TOOL BOX



CODE	FEATURES	PCS
OTC0013	13"	1/6
OTC0016	16"	1/6
OTC0018	18"	1/6
OTC0021	21"	1/6

### CLASSIC PLASTIC TOOL BOX



CODE	FEATURES	PCS
OTCR017	17"	1/6
OTCR020	20"	1/6

### CLASSIC PLASTIC TOOL BOX BACK



CODE	FEATURES	PCS
OTCSR13	13"	1/6
OTCSR16	16"	1/6
OTCSR18	18"	1/6
OTCSR21	21"	1/6

### CLASSIC PLASTIC TOOL BOX BACK



CODE	FEATURES	PCS
OTCOR13	13"	1/6
OTCOR16	16"	1/6
OTCOR18	18"	1/6
OTCOR21	21"	1/6

### ORGANIZER DRAWERS TOOL BOX



CODE	FEATURES	PCS
OTR017	17"	6
OTR021	21"	6



**PORTABLE ORG. DRAWER TOOL BOX**



CODE	FEATURES	PCS
OTRL017	17"	6
OTRL021	21"	6

**FLAT COVER DRAWERS TOOL BOX**



CODE	FEATURES	PCS
OTCRS017	17"	6
OTCRS021	21"	6

**ECO TOOLBOX - BLACK"**



CODE	FEATURES	PCS
OTCET12	12"	1/6
OTCET16	16"	1/6

**ECO TOOLBOX - TRANSPARENT"**



CODE	FEATURES	PCS
OTCST12	12" Transparent	1/6
OTCST16	16" Transparent	1/6

**WHEELED TOOL BOX**



CODE	FEATURES	PCS
OTCKP28	380 x 595 x 420MM	2

**CLASSIC ORGANIZER**



CODE	FEATURES	PCS
CNSORG9	230x150x33 mm	24
CNSORG11	276x203x42 mm	24
CNSORG13	324x247x51 mm	12



### ORGANIZER



CODE	FEATURES	PCS
OTK0005	5"	36
OTK0007	7"	36
OTK0010	10"	24
OTK0013	13"	12
OTK0018	18"	12
OTK0024	24"	6

### DOUBLE-SIDED ORGANIZER



CODE	FEATURES	PCS
OTK0560	Duplex, Number of Partitions	24

### PLASTIC DRAWER BOX



CODE	FEATURES	PCS
OTK10	85x120x40	50
OTK20	100x140x52	40
OTK30	110x120x62	40
OTK31	110x120x62	40
OTK32	110x120x62	40
OTK35	110x170x65	40
OTK40	124x196x80	32
OTK45	175x230x110	24
OTK50	140x230x98	32
OTK55	212x302x126	12
OTK56	212x302x126	12
OTK60	260x340x150	6

### PLASTIC BOX CONNECTOR



CODE	FEATURES
OTBA10	6 pack
OTBA15	6 pack
OTBA20	6 pack
OTBA25	6 pack
OTBA30	6 pack
OTBA35	6 pack
OTBA40	6 pack

### PLASTIC BOX ORANGE - BLACK - GREY



ORANGE

CODE	FEATURES	PCS
OTR10	103x165x75	60
OTR15	125x195x90	60
OTR20	152x245x122	60
OTR25	200x300x130	30
OTR30	217x360x155	30
OTR35	265x420x177	20
OTR40	310x490x195	12



BLACK

CODE	FEATURES	PCS
OTS10	103x165x75	60
OTS15	125x195x90	60
OTS20	152x245x122	60
OTS25	200x300x130	30
OTS30	217x360x155	30
OTS35	265x420x177	20
OTS40	310x490x195	12

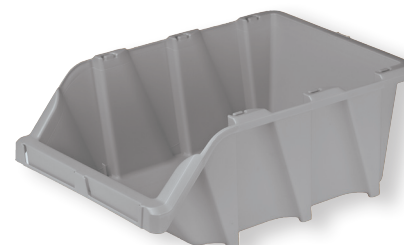

GREY

CODE	FEATURES	PCS
OTG10	103x165x75	60
OTG15	125x195x90	60
OTG20	152x245x122	60
OTG25	200x300x130	30
OTG30	217x360x155	30
OTG35	265x420x177	20
OTG40	310x490x195	12



LADDER



CODE	FEATURES	PCS
MR03S	3+1 Step	1
MR04S	4+1 Step	1
MR05S	5+1 Step	1
MR06S	6+1 Step	1
MR07S	7+1 Step	1
MR08S	8+1 Step	1
MR09S	9+1 Step	1

LADDER



CODE	FEATURES	PCS
MR03R	3+1 Step	1
MR04R	4+1 Step	1
MR05R	5+1 Step	1
MR06R	6+1 Step	1
MR07R	7+1 Step	1
MR08R	8+1 Step	1
MR09R	9+1 Step	1



## LADDER



CODE	FEATURES	PCS
MR602T	2 Step	4
MR603T	3 Step	4
MR604T	4 Step	4

## MULTI PURPOSE LADDER

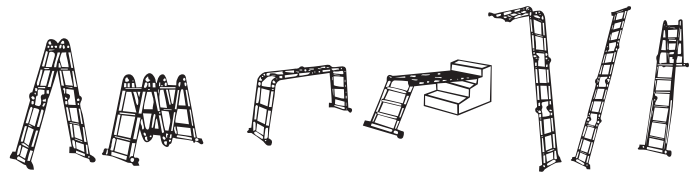

CODE	FEATURES	PCS
RHT1702100403	4 Folds 3 Step, 3,70m	1
RHT1702100404	4 Folds 4 Step, 4,73m	1
RHT1702100405	4 Folds 5 Step, 5,73m	1
RHT1702100406	4 Folds 6 Step, 6,73m	1



# PRODUCT STAND

## RODEX

## RODEX



PREMIUM QUALITY TOOLS [f](#) [@](#) [v](#) [RODEXTOOLS](#)

PREMIUM QUALITY TOOLS [f](#) [@](#) [v](#) [RODEXTOOLS](#)

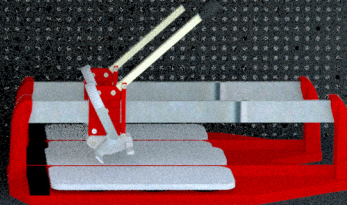
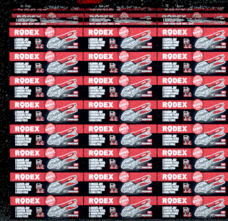

RODEX [f](#) [@](#) [v](#) [RODEXTOOLS](#)

RODEX [f](#) [@](#) [v](#) [RODEXTOOLS](#)

For more information about  
products can visit our website.



[www.rodextools.com](http://www.rodextools.com)

# CHOICE OF PROFESSIONALS



 [rodexpower.com](http://rodexpower.com)

   **RODEXTOOLS**



**AKDEMİR GLOBAL DIŐ TİCARET A.Ő.**

📍 Mahmutbey Mah. İstoç Ticaret Merkezi 2416. Sok.  
AKTEM PLAZA Kat 12-13 Bağcılar - İstanbul / TÜRKİYE

☎ 0212 771 04 66 📠 0212 659 09 41

🌐 [akdemirglobal.com](http://akdemirglobal.com) ✉ [info@akdemirglobal.com](mailto:info@akdemirglobal.com)

📱 [akdemirglobal](#)